









1

 D1 6	 C 12
 A 16	 J4 14

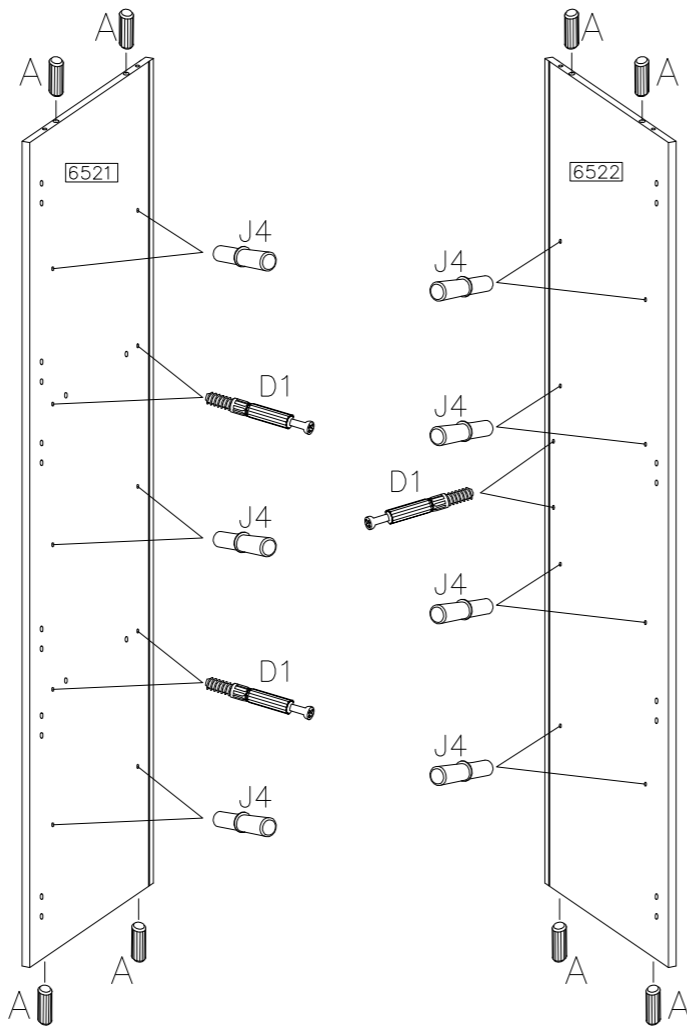
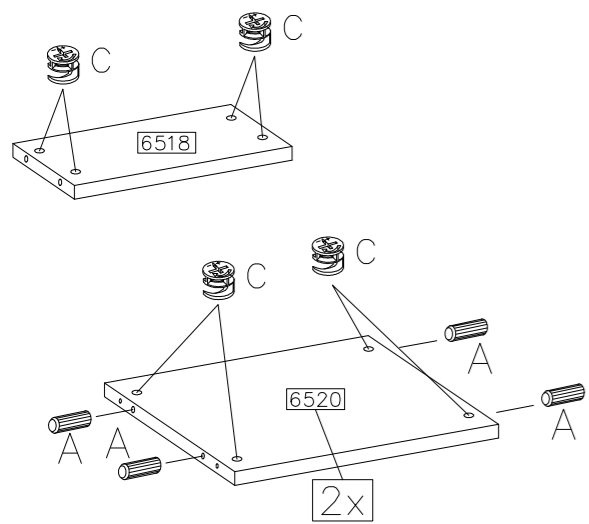
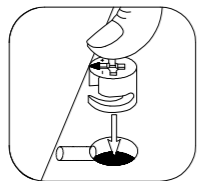

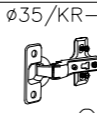

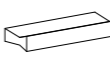

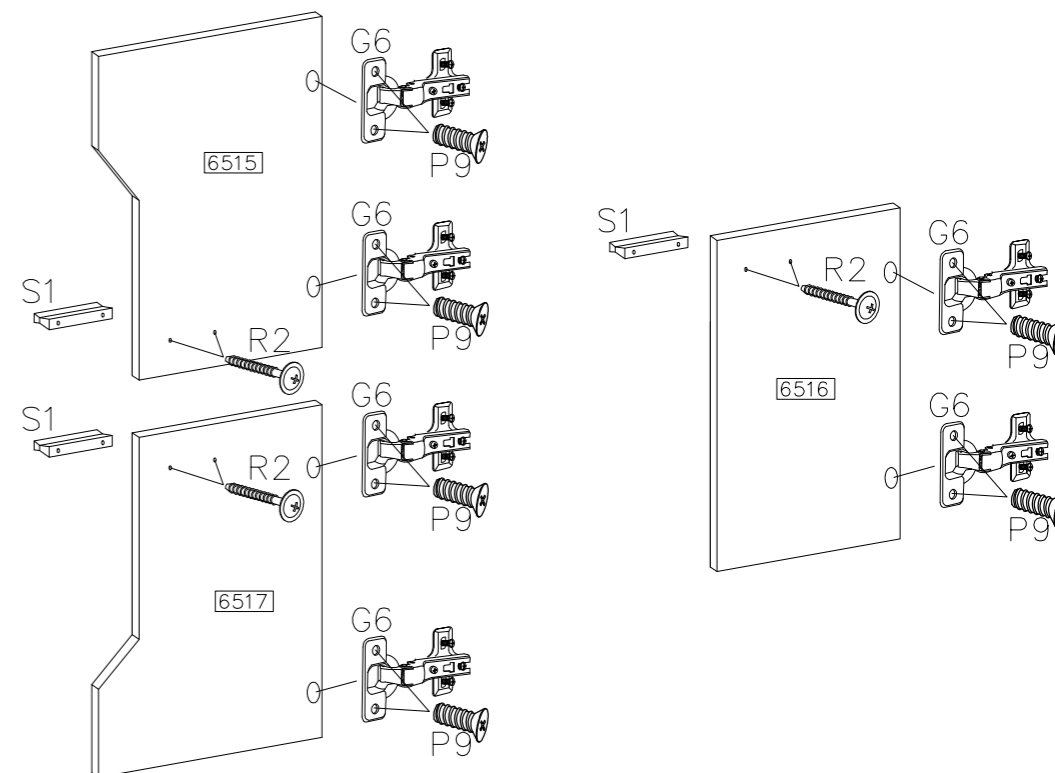
8

 G6 6	 P9 12	 R2 6	 S1 3
---	--	---	---





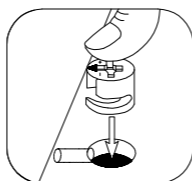
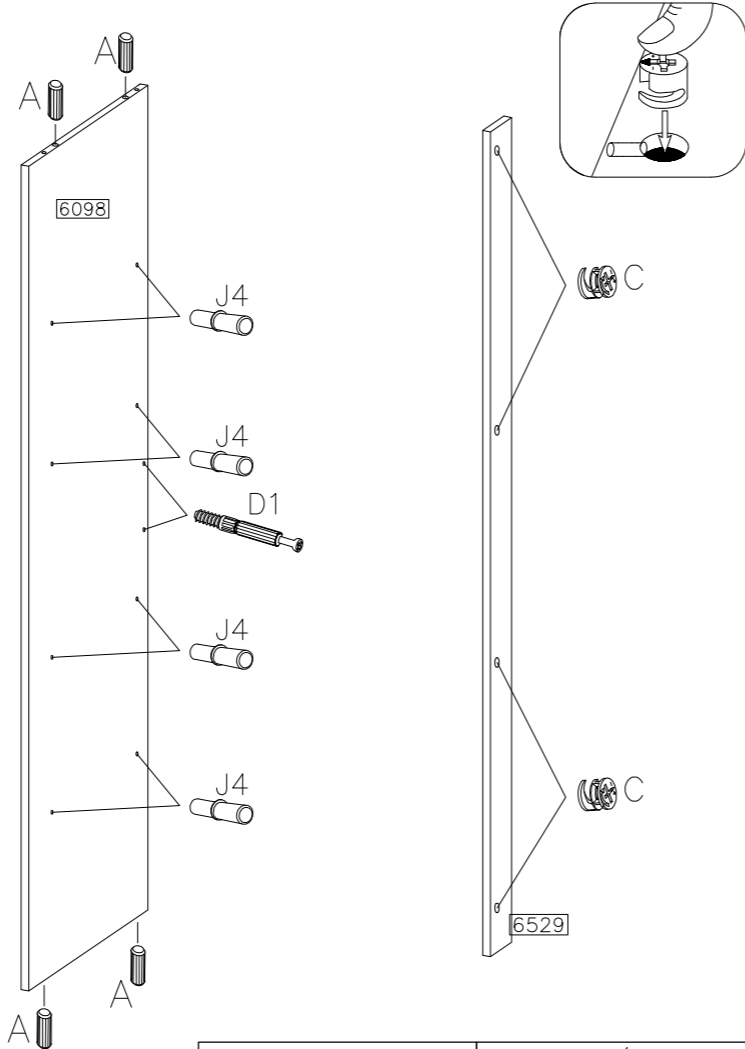
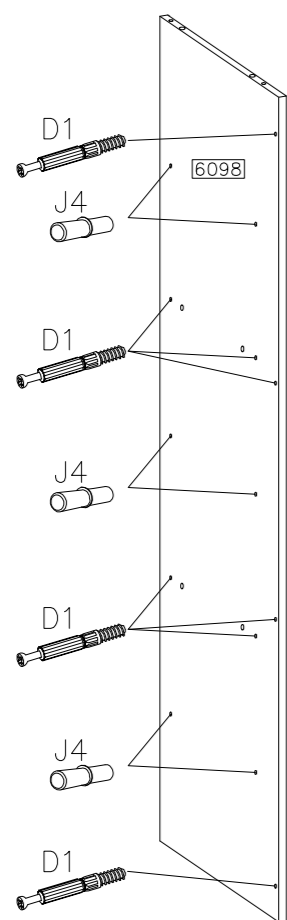

2

 D1 10
 A 4
 J4 14
 C 4

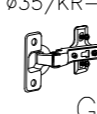

9

 G6 4	 P9 8	 P3 4	 L4 10	 P8 10
--	--	--	---	---

